

# MEMBRAPOR

## SPECIFICATION SHEET FOR O<sub>3</sub> SENSOR TYPE O3/C-200

### PERFORMANCE CHARACTERISTICS

Nominal Range	0 – 200 ppm
Maximum Overload	400 ppm
Expected Operation Life	2 years in air
Output Signal	- 400 ± 130 nA/ppm
Resolution	0,1 ppm
Temperature Range	- 20 °C to 45 °C
Pressure Range	Atmospheric ± 10%
Pressure Coefficient	No data
T <sub>80</sub> Response Time	< 60 sec
Relative Humidity Range	15 % to 90 % R.H. non-condensing
Typical Baseline Range (pure air, 20°C)	< 0,2 ppm
Maximum Zero Shift (+20°C to +40°C)	0,2 ppm
Typical Long Term Output Drift	< 2% signal loss/month
Recommended Load Resistor	10 Ohm
Bias Voltage	Not recommended
Repeatability	5 % of signal
Output Linearity	Linear

### PHYSICAL CHARACTERISTICS

Weight	~ 13 g
Position Sensitivity	None
Storage Life	Six months in container
Recommended Storage Temperature	5 °C – 20 °C
Warranty Period	12 months from date of dispatch

### Compact-Size Outline Dimensions

#### BOTTOM VIEW

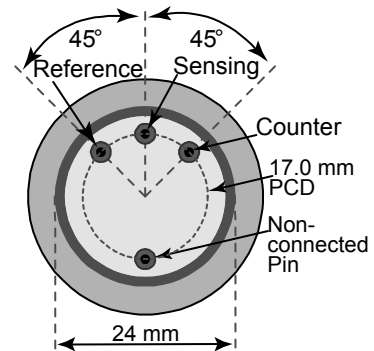

#### SIDE VIEW

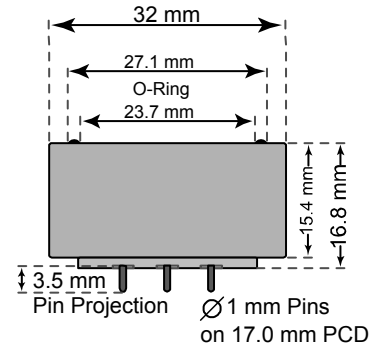

### CROSS-SENSITIVITY DATA

Interfering Gas	Concentration	Reading
CO	200 ppm	0 ppm
H <sub>2</sub>	200 ppm	0 ppm
SO <sub>2</sub>	5 ppm	0 ppm
H <sub>2</sub> S		ND
NO	35 ppm	0 ppm
NO <sub>2</sub>	5 ppm	~ 5 ppm
Ethylene	100 ppm	0 ppm
Cl <sub>2</sub>	5 ppm	~ 4 ppm

Performance data conditions:  
20 °C, 50% RH and 1013 mbar

### APPLICATIONS

Continuous Air Quality Monitoring  
Safety and Environmental Control

The data contained in this document is for guidance only. Membrapor AG accepts no liability for any consequential losses, injury or damage resulting from the use of this document or the information contained within it. The data is given for guidance only. Customers should test under their own conditions, to ensure that the sensors are suitable for their own requirements.

REV.: 12/2007

Page 1 of 1

Phone: +41 43 311 72 00  
Fax : +41 43 311 72 01  
Email: info@membrapor.ch  
www.membrapor.ch

MEMBRAPOR AG  
Rautistrasse 164  
CH-8048 Zürich  
Switzerland